

BS 12500, 12750, & 12900

1 1/4" poly by 1/2" FPT

1 1/4" poly by 3/4" FPT

1 1/4" poly by
Swing Pipe Barb

Dimensions (installed):

BS 12900:

- 4.46 inches - bottom of saddle to top of swing pipe barb
- 2.75 inches - top of pipe to top of swing pipe barb
- 2.60 inches at widest point

BS 12750 & 12500:

- 3.58 inches - bottom of saddle to top of spike
- 1.7 inches - top of pipe to top of spike
- 2.60 inches at widest point

- For use on 1 1/4" 80# or 100# polyethylene pipe*
- 7 Gallons per minute at 40 PSI
- 12 Gallons per minute at 60 PSI
- 40% less friction loss than insert fittings
- Friction loss equivalent of 3.8 ft of pipe
- Withstands repeated freeze/thaw cycles and ground shift & sheering
- Made of high grade ABS material
- Tested to over 1 million on/off cycles without a leak

*Withstands over 400 PSI without a leak. Pipe will burst first.

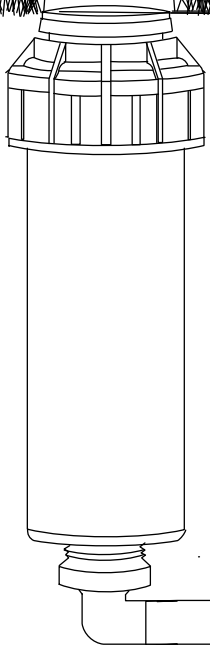
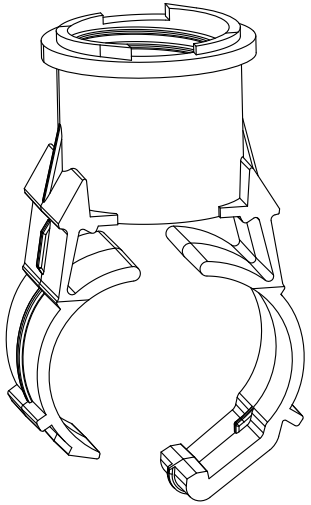

BS 12900 should be mounted horizontal

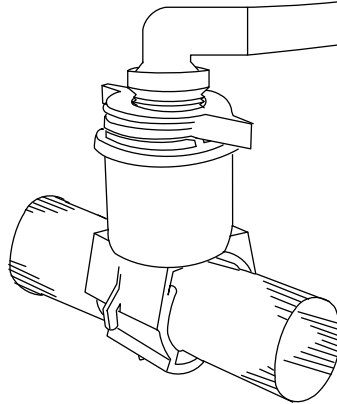
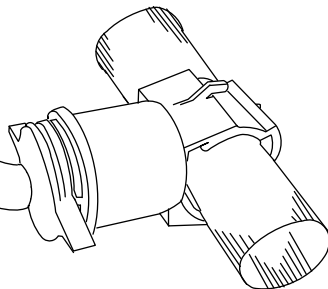

BS 12500 with Swing
Pipe Fitting Application

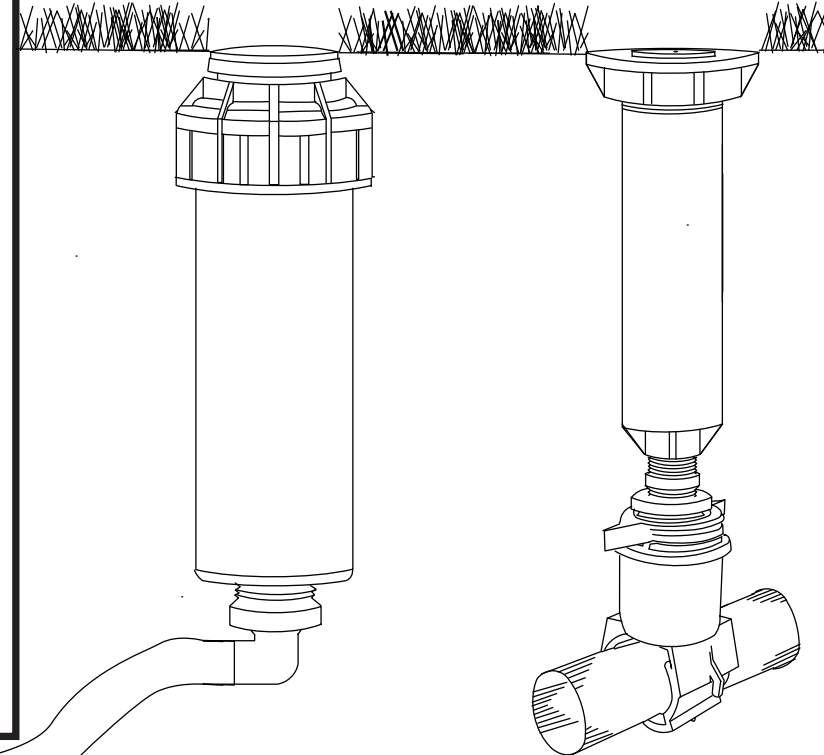

BS 12750 with 3/4" to
1/2" Riser Application

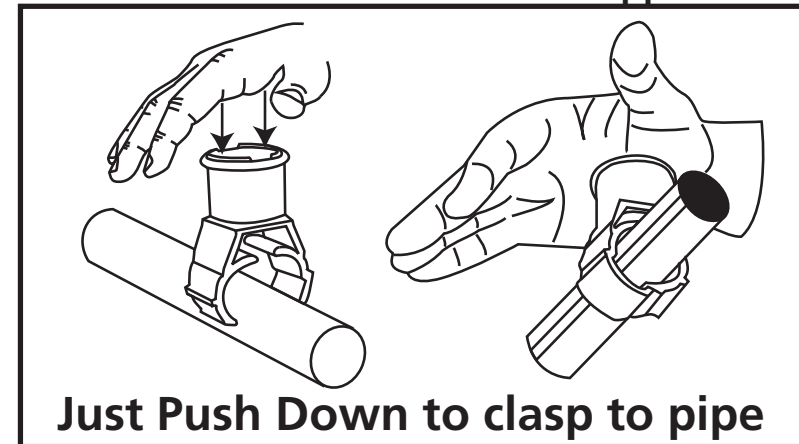

Just Push Down to clasp to pipe